

Data sheet | Item number: 253-116

2-conductor PCB terminal block; 1.5 mm²; Pin spacing 5 mm; 16-pole; PUSH WIRE®

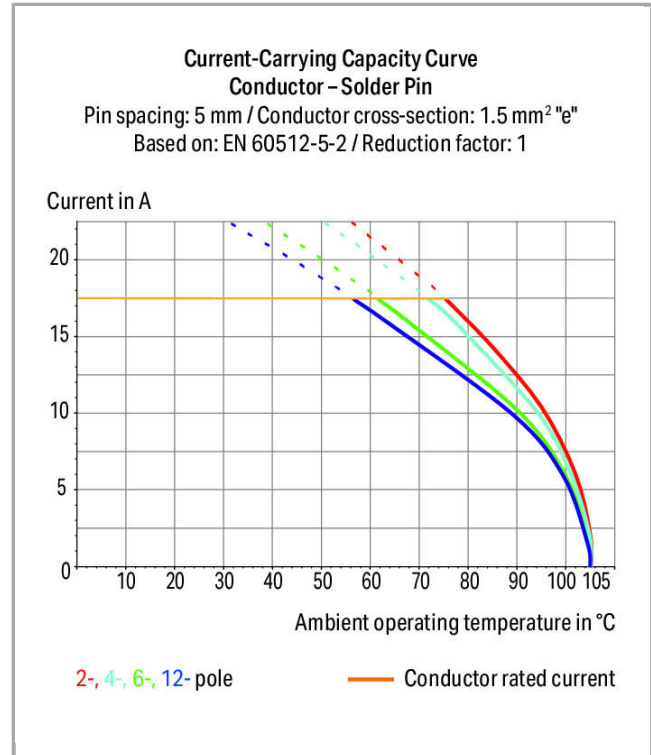

253-116

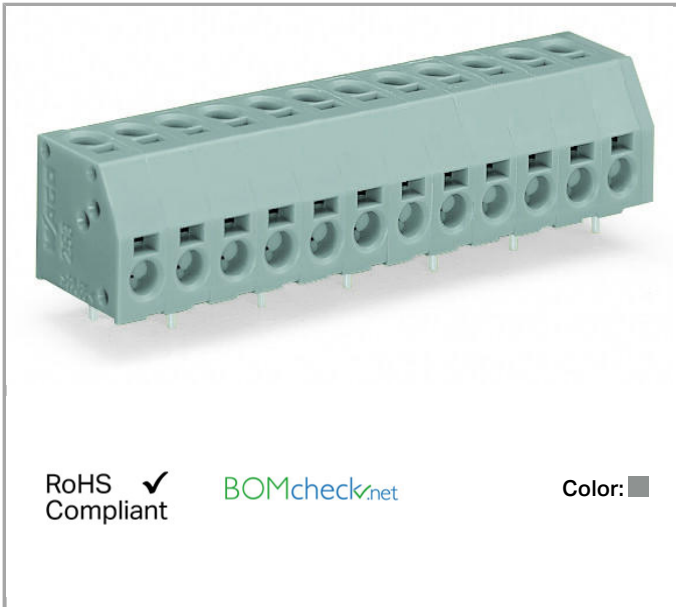

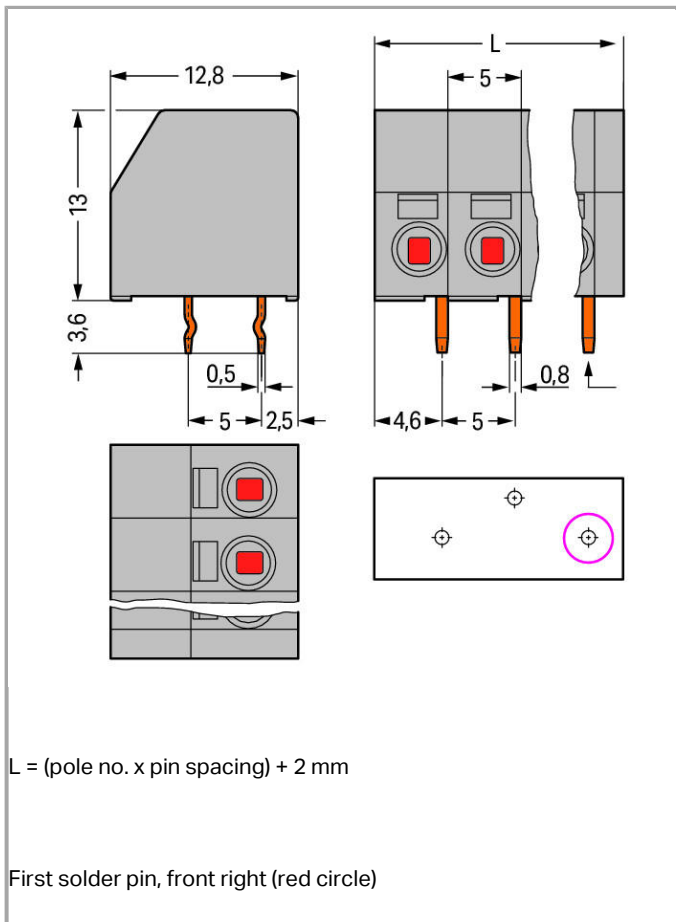

Item description

- PCB terminal strips with PUSH WIRE® connection and screwdriver actuation
- Double-conductor connection provides top-entry (vertical) and/or side-entry (horizontal) wiring
- Push-in termination of solid conductors
- Double entries for power supply and potential distribution

Data

Electrical data

Ratings per IEC/EN 60664-1

Rated voltage (III / 3)	320 V
Rated impulse voltage (III / 3)	4 kV
Rated voltage (III / 2)	320 V
Rated impulse voltage (III / 2)	4 kV
Rated voltage (II / 2)	630 V
Rated impulse voltage (II / 2)	4 kV
Rated current	17.5 A

Approvals per UL 1059

Rated voltage UL (Use Group B)	300 V
Rated current UL (Use Group B)	8 A
Rated voltage UL (Use Group D)	300 V
Rated current UL (Use Group D)	8 A

Approvals per CSA

Rated voltage CSA (Use Group B)	300 V
Rated current CSA (Use Group B)	8 A
Rated voltage CSA (Use Group D)	300 V
Rated current CSA (Use Group D)	8 A

Connection data

Connection type (1)	PUSH WIRE® connection
Connection technology	PUSH WIRE®
Number of connection points (connection type)	1
Actuation type	Operating tool
Solid conductor	0.5 ... 1.5 mm ² / 20 ... 16 AWG
Strip length	8.5 ... 9.5 mm / 0.33 ... 0.37 inch
Note (strip length)	7 ... 8 mm / 0.28 ... 0.31 in. (for wiring on both sides)
Conductor entry angle to the PCB	0°
Connection type (2)	PUSH WIRE® connection
Connection technology 2	PUSH WIRE®
Number of connection points	1
Solid conductor (2)	0.5 ... 1.5 mm ² / 20 ... 16 AWG
Strip length (2)	8.5 ... 9.5 mm / 0.33 ... 0.37 inch
Note (strip length) 2	7 ... 8 mm / 0.28 ... 0.31 in. (for wiring on both sides)
Conductor entry angle to the PCB 2	90°
No. of poles	16
Total number of connection points	32
Total number of potentials	16
Number of connection types	2
Number of levels	2

Geometrical Data

Pin spacing	5 mm / 0.197 inch
Width	82 mm / 3.228 inch
Height	16.6 mm / 0.654 inch

Height from the surface	13 mm / 0.512 inch
Depth	12.8 mm / 0.504 inch
Solder pin length	3.6 mm
Solder pin dimensions	0.5 x 0.8 mm
Drilled hole diameter (tolerance)	1.1 ^(-...+0.1) mm

PCB contact

PCB contact	THT
Solder pin arrangement	over the entire terminal strip, staggered
Number of solder pins per potential	1

Material Data

Color	gray
Material group	I
Insulating material	Polyamide 66 (PA 66)
Flammability class per UL94	V0
Clamping spring material	Chrome nickel spring steel (CrNi)
Contact material	Electrolytic copper (E _{Cu})
Contact plating	tin-plated
Fire load	0.282 MJ
Weight	13.774 g

Environmental Requirements

Limit temperature range	-60 ... +105 °C
-------------------------	-----------------

Commercial data

Product Group	4 (Printed Circuit)
Country of origin	CN
GTIN	4044918689694
Customs Tariff No.	85369010000

Approvals / Certificates

Country specific Approvals



Logo	Approval	Additional Approval Text	Certificate name
	CCA DEKRA Certification B.V.	EN 60998	NTR NL 6580
	CCA	EN 60998	2126302.02

DEKRA Certification B.V.



	CCA DEKRA Certification B.V.	EN 60947	NTR NL-7649
	CCA DEKRA Certification B.V.	EN 60947	NTR NL-7122
	ENEC DEKRA Certification B.V.	EN 60947	71-101931
	ENEC DEKRA Certification B.V.	EN 60947	2160584.27
	VDE VDE Prüf- und Zertifizierungsinstitut	EN 60998	40028668

UL-Approvals

Logo	Approval	Additional Approval Text	Certificate name
	cURus Underwriters Laboratories Inc.	UL 1059	E45172 sec. 6
	cURus Underwriters Laboratories Inc.	UL 1059	E45172 sec. 6
	UL UL International Germany GmbH	UL 1977	E45171

Compatible products

Marking accessories

Item no.: 210-332/500-202

Marking strips; as a DIN A4 sheet; MARKED; 1-16 (160x); Height of marker strip: 3 mm; Strip length 182 mm; Horizontal marking; Self-adhesive 210-332
/500-202

Item no.: 210-332/500-204
 Marking strips; as a DIN A4 sheet; MARKED; 17-32 (160x); Height of marker strip: 3 mm; Strip length 182 mm; Horizontal marking; Self-adhesive 210-332
/500-204

Item no.: 210-332/500-205
 Marking strips; as a DIN A4 sheet; MARKED; 1-32 (80x); Height of marker strip: 3 mm; Strip length 182 mm; Horizontal marking; Self-adhesive 210-332
/500-205

Item no.: 210-332/500-206
 Marking strips; as a DIN A4 sheet; MARKED; 33-48 (160x); Height of marker strip: 3 mm; Strip length 182 mm; Horizontal marking; Self-adhesive 210-332
/500-206



Item no.: 210-833
 Marking strips; on reel; 6 mm wide; plain; Self-adhesive 210-833

tools

 **Item no.: 210-647**
 Operating tool with partially insulated shaft; Blade (2.5 x 0.4) mm; short 210-647

 **Item no.: 210-648**
 Operating tool with partially insulated shaft; Blade (2.5 x 0.4) mm; short; angled 210-648

 **Item no.: 210-719**
 Operating tool with partially insulated shaft; Type 1, blade (2.5 x 0.4) mm 210-719

Downloads

CAD/CAE - Smart Data

CAD data

3D Download 253-116 URL [Download](#)

PCB libraries

TARGET Library for WAGO PCB Terminal Blocks 1.1.0 [Download](#)
 Compatible with TARGET PCB Design Software Version 17.x Oct 6, 2014 27.1 MB

EAGLE Library for WAGO PCB Terminal Blocks 2.1 [Download](#)
 Compatible with EAGLE PCB Design Software Version 6.x or higher Oct 6, 2014 23.9 MB

DesignSpark Library for WAGO PCB Terminal Blocks 2.1 [Download](#)
 Compatible with DesignSpark PCB Version 4.x or higher Oct 6, 2014 22.5 MB



Subject to changes.
